



# NEC's HIGH CMR , 10 Mbps OPEN COLLECTOR OUTPUT TYPE 8-PIN SSOP (SO-8) HIGH-SPEED OPTOCOUPLER

PS9814-1,-2

## DESCRIPTION

NEC's PS9814-1 and PS9814-2 are active-low type high-speed optocouplers that use a GaAlAs light-emitting diode on the input side and a photodetector IC that includes a photodiode and a signal processor on the same chip on the output side.

The PS9814-1, -2 are designed specifically for high common mode transient immunity (CMR) and low pulse width distortion, the PS9814-2 is suitable for high density applications.

## FEATURES

- **40% REDUCTION OF MOUNTING AREA:**  
5-pin SOP × 2
- **HIGH COMMON MODE TRANSIENT IMMUNITY:**  
 $C_{MH}, C_{ML} = \pm 20 \text{ kV}/\mu\text{s TYP.}$
- **PULSE WIDTH DISTORTION:**  
 $|t_{PHL} - t_{PLH}| = 3 \text{ ns TYP.}$
- **HIGH-SPEED:**  
10 Mbps
- **HIGH ISOLATION VOLTAGE:**  
 $BV = 2\,500 \text{ Vr.m.s.}$
- **OPEN COLLECTOR OUTPUT**
- **ORDERING NUMBER OF TAPE PRODUCT:**  
PS9814-1-F3, F4: 1 500 pcs/reel  
PS9814-2-F3, F4: 1 500 pcs/reel
- **Pb-FREE PRODUCT**
- **SAFETY STANDARDS:**  
UL approved: File No. E72422  
DIN EN60747-5-2 (VDE0884 Part2) approved  
No.40008347 (option)

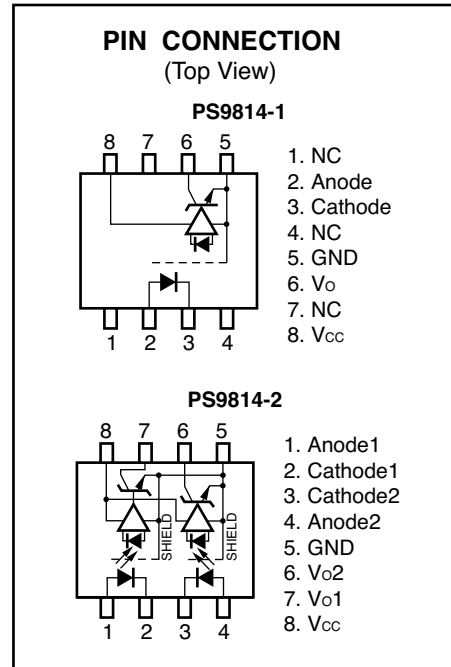

## TRUTH TABLE

LED	OUTPUT
ON	L
OFF	H

## APPLICATIONS

- Measurement Equipment
- PDP
- Industrial Automation

The information in this document is subject to change without notice. Before using this document, please confirm that this is the latest version.

PACKAGE DIMENSIONS (UNIT: mm)

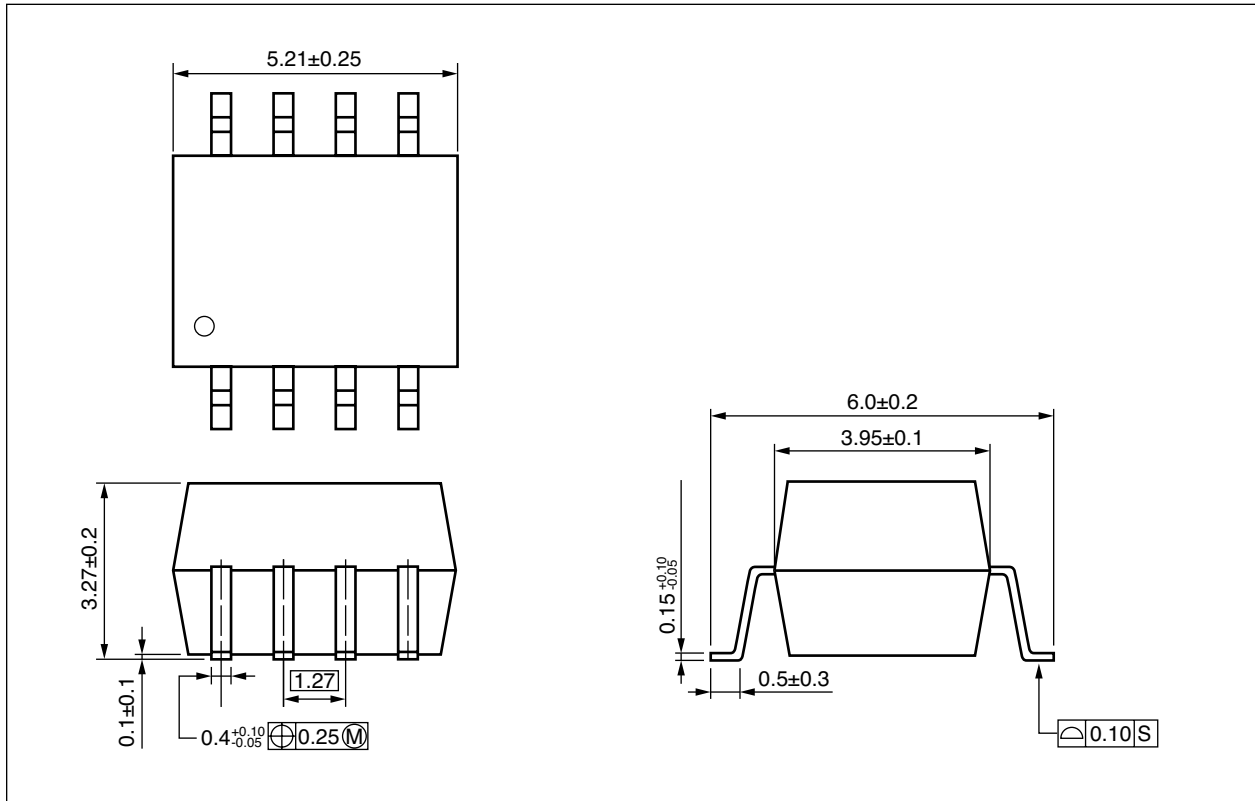

MARKING EXAMPLES

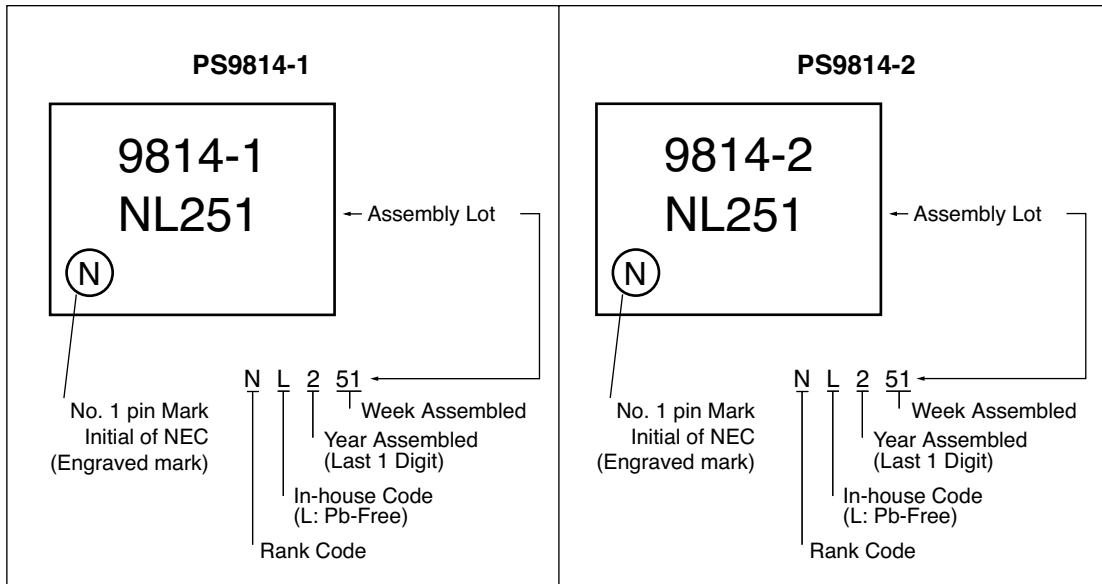

## ORDERING INFORMATION

PART NUMBER	ORDER NUMBER	SOLDER PLATING SPECIFICATION	PACKING STYLE	SAFETY STANDARD APPROVAL	APPLICATION PART NUMBER*1
PS9814-1	PS9814-1-A	Pb-Free*2	20 pcs (Tape 20 pcs cut)	Standard products (UL approved)	PS9814-1
PS9814-1-F3	PS9814-1-F3-A		Embossed Tape 1 500 pcs/reel		
PS9814-1-F4	PS9814-1-F4-A				
PS9814-2	PS9814-2-A		20 pcs (Tape 20 pcs cut)		
PS9814-2-F3	PS9814-2-F3-A		Embossed Tape 1 500 pcs/reel	DIN EN60747-5-2 (VDE0884 Part2) Approved (Option)	PS9814-1
PS9814-2-F4	PS9814-2-F4-A				
PS9814-1-V	PS9814-1-V-A		20 pcs (Tape 20 pcs cut)		
PS9814-1-V-F3	PS9814-1-V-F3-A		Embossed Tape 1 500 pcs/reel		
PS9814-1-V-F4	PS9814-1-V-F4-A			DIN EN60747-5-2 (VDE0884 Part2) Approved (Option)	PS9814-2
PS9814-2-V	PS9814-2-V-A		20 pcs (Tape 20 pcs cut)		
PS9814-2-V-F3	PS9814-2-V-F3-A		Embossed Tape 1 500 pcs/reel		
PS9814-2-V-F4	PS9814-2-V-F4-A				

\*1 For the application of the Safety Standard, following part number should be used.

\*2 With regards to terminal solder (the solder contains lead) plated products (conventionally plated), contact your nearby sales office.

**ABSOLUTE MAXIMUM RATINGS** (T<sub>A</sub> = 25°C, unless otherwise specified)

PARAMETER		SYMBOL	RATINGS		UNIT
			PS9814-1	PS9814-2	
Diode	Forward Current	I <sub>F</sub>	20* <sup>1</sup>	15* <sup>2</sup>	mA
	Reverse Voltage	V <sub>R</sub>	5		V/ch
Detector	Supply Voltage	V <sub>CC</sub>	7		V
	Output Voltage	V <sub>O</sub>	7		V/ch
	Output Current	I <sub>O</sub>	25		mA/ch
	Power Dissipation* <sup>3</sup>	P <sub>C</sub>	40		mW/ch
Isolation Voltage* <sup>4</sup>		BV	2 500		Vr.m.s.
Operating Ambient Temperature		T <sub>A</sub>	-40 to +85		°C
Storage Temperature		T <sub>stg</sub>	-55 to +125		°C

\*1 Reduced to 0.3 mA/°C at T<sub>A</sub> = 60°C or more.

\*2 Reduced to 0.1 mA/°C at T<sub>A</sub> = 60°C or more.

\*3 Applies to output pin V<sub>O</sub>. Reduced to 1.5 mW/°C at T<sub>A</sub> = 65°C or more.

\*4 AC voltage for 1 minute at T<sub>A</sub> = 25°C, RH = 60% between input and output.

**RECOMMENDED OPERATING CONDITIONS**

PARAMETER	SYMBOL	MIN.	TYP.	MAX.	UNIT
Low Level Input Voltage	V <sub>FL</sub>	0		0.8	V
High Level Input Current	I <sub>FH</sub>	6.3	10	12.5	mA
Supply Voltage	V <sub>CC</sub>	4.5	5.0	5.5	V
Pull-up Resistance	R <sub>L</sub>	330		4 k	Ω
TLL (R <sub>L</sub> = 1 kΩ, loads)	N			5	

**ELECTRICAL CHARACTERISTICS** ( $T_A = -40$  to  $+85^\circ\text{C}$ , unless otherwise specified)

PARAMETER		SYMBOL	CONDITIONS	MIN.	TYP. *1	MAX.	UNIT
Diode	Forward Voltage	$V_F$	$I_F = 10 \text{ mA}$ , $T_A = 25^\circ\text{C}$	1.4	1.65	1.8	V
	Reverse Current	$I_R$	$V_R = 3 \text{ V}$ , $T_A = 25^\circ\text{C}$			10	$\mu\text{A}$
	Terminal Capacitance	$C_t$	$V = 0 \text{ V}$ , $f = 1 \text{ MHz}$ , $T_A = 25^\circ\text{C}$		30		pF
Detector	High Level Output Current	$I_{OH}$	$V_{CC} = V_O = 5.5 \text{ V}$ , $V_F = 0.8 \text{ V}$		0.02	250	$\mu\text{A}$
	Low Level Output Voltage*2	$V_{OL}$	$V_{CC} = 5.5 \text{ V}$ , $I_F = 5 \text{ mA}$ , $I_{OL} = 13 \text{ mA}$		0.15	0.6	V
	High Level Supply Current (PS9814-1)	$I_{CCH}$	$V_{CC} = 5.5 \text{ V}$ , $I_F = 0 \text{ mA}$ , $V_O = \text{open}$		3	8	mA
	High Level Supply Current (PS9814-2)				6	15	
	Low Level Supply Current (PS9814-1)	$I_{CCL}$	$V_{CC} = 5.5 \text{ V}$ , $I_F = 10 \text{ mA}$ , $V_O = \text{open}$		7.0	11	
	Low Level Supply Current (PS9814-2)				14	21	
Coupled	Threshold Input Current (H $\rightarrow$ L)	$I_{FHL}$	$V_{CC} = 5 \text{ V}$ , $V_O = 0.8 \text{ V}$ , $R_L = 350 \Omega$		2	5	mA
	Input-Output Isolation Resistance	$R_{I-O}$	$V_{I-O} = 1 \text{ kV}_{DC}$ , $R_H = 40$ to $60\%$ , $T_A = 25^\circ\text{C}$	$10^{11}$			$\Omega$
	Insulation Resistance (Input-Input), (PS9814-2)	$R_{I-I}$	$V_{I-I} = 1 \text{ kV}_{DC}$ , $R_H = 40$ to $60\%$ , $T_A = 25^\circ\text{C}$	$10^{10}$			
	Input-Output Isolation Capacitance	$C_{I-O}$	$V = 0 \text{ V}$ , $f = 1 \text{ MHz}$ , $T_A = 25^\circ\text{C}$		0.6		pF
	Insulation Capacitance (Input-Input), (PS9814-2)	$C_{I-I}$			0.3		
	Propagation Delay Time (H $\rightarrow$ L)*3	$t_{PHL}$	$V_{CC} = 5 \text{ V}$ , $R_L = 350 \Omega$ , $I_F = 7.5 \text{ mA}$	$T_A = 25^\circ\text{C}$	54	75	ns
	Propagation Delay Time (L $\rightarrow$ H)*3			$t_{PLH}$	$T_A = 25^\circ\text{C}$	51	
	Rise Time	$t_r$	$V_{CC} = 5 \text{ V}$ , $R_L = 350 \Omega$ , $I_F = 7.5 \text{ mA}$		20		
	Fall Time	$t_f$	$V_{CC} = 5 \text{ V}$ , $R_L = 350 \Omega$ , $I_F = 7.5 \text{ mA}$		10		
	Pulse Width Distortion (PWD)*3	$ t_{PHL} - t_{PLH} $	$V_{CC} = 5 \text{ V}$ , $R_L = 350 \Omega$ , $I_F = 7.5 \text{ mA}$		3	50	
	Propagation Delay Skew	$t_{PSK}$	$V_{CC} = 5 \text{ V}$ , $R_L = 350 \Omega$ , $I_F = 7.5 \text{ mA}$			60	
	Common Mode Transient Immunity at High Level Output*4	$CM_H$	$V_{CC} = 5 \text{ V}$ , $R_L = 350 \Omega$ , $T_A = 25^\circ\text{C}$ , $I_F = 0 \text{ mA}$ , $V_O > 2 \text{ V}$ , $V_{CM} = 1 \text{ kV}$	10	20		kV/ $\mu\text{s}$
	Common Mode Transient Immunity at Low Level Output*4	$CM_L$	$V_{CC} = 5 \text{ V}$ , $R_L = 350 \Omega$ , $T_A = 25^\circ\text{C}$ , $I_F = 7.5 \text{ mA}$ , $V_O < 0.8 \text{ V}$ , $V_{CM} = 1 \text{ kV}$	10	20		

\*1 Typical values at  $T_A = 25^\circ\text{C}$ \*2 Because  $V_{OL}$  of 2 V or more may be output when LED current input and when output supply of  $V_{CC} = 2.6 \text{ V}$  or less, it is important to confirm the characteristics (operation with the power supply on and off) during design, before using this device.

\*3 Test circuit for propagation delay time

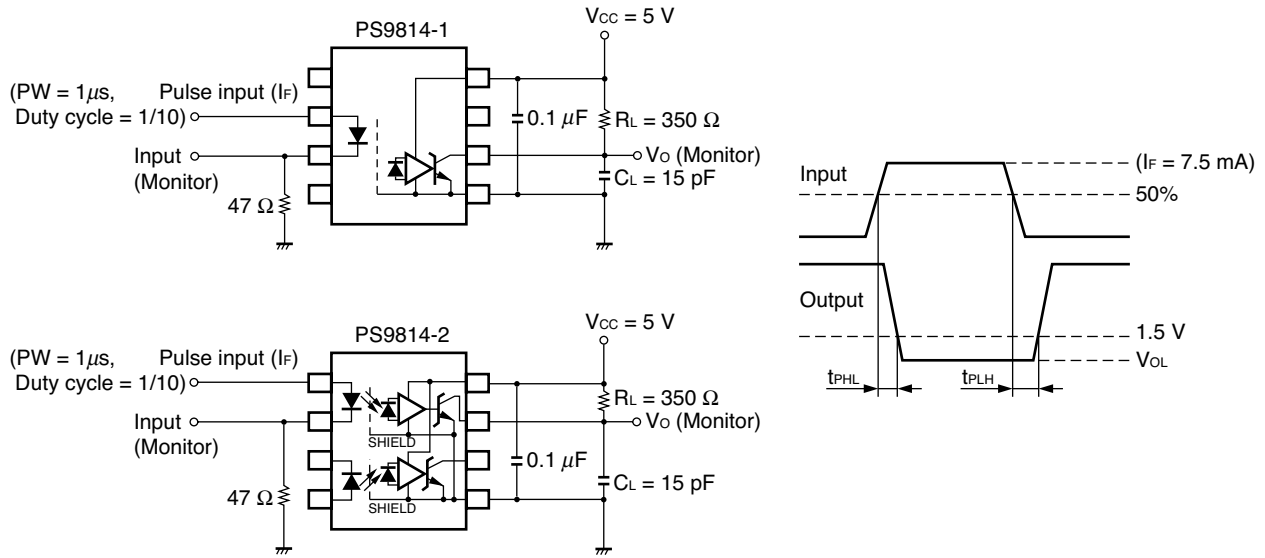

**Remark**  $C_L$  includes probe and stray wiring capacitance.

\*4 Test circuit for common mode transient immunity

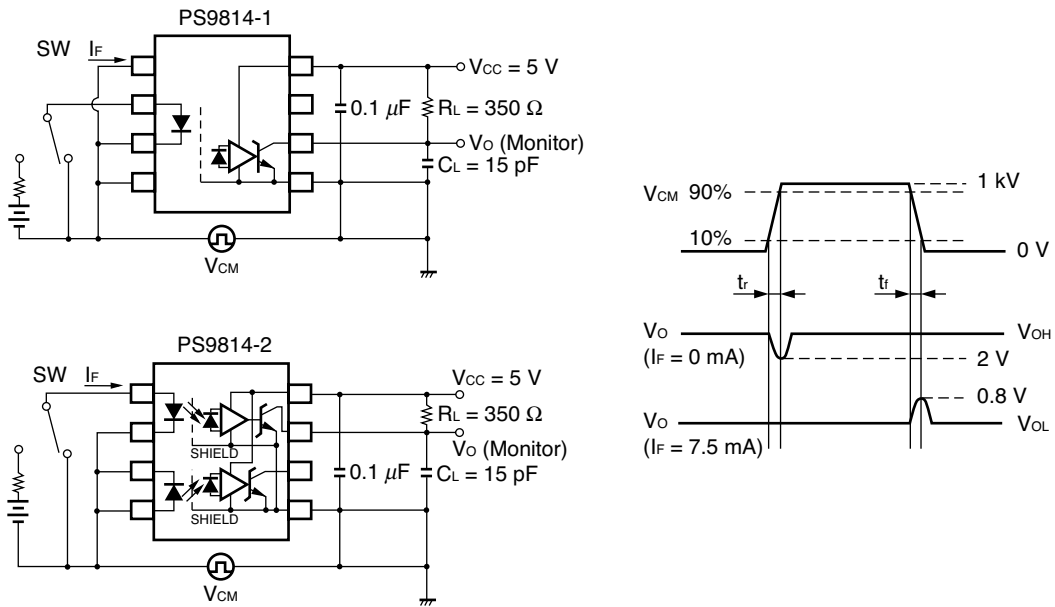

**USAGE CAUTIONS**

1. This product is weak for static electricity by designed with high-speed integrated circuit so protect against static electricity when handling.
2. By-pass capacitor of  $0.1\ \mu\text{F}$  is used between  $V_{CC}$  and GND near device. Also, ensure that the distance between the leads of the photocoupler and capacitor is no more than  $10\text{ mm}$ .
3. Avoid storage at a high temperature and high humidity.

**TYPICAL CHARACTERISTICS** ( $T_A = 25^\circ\text{C}$ , unless otherwise specified)

**MAXIMUM FORWARD CURRENT vs. AMBIENT TEMPERATURE**

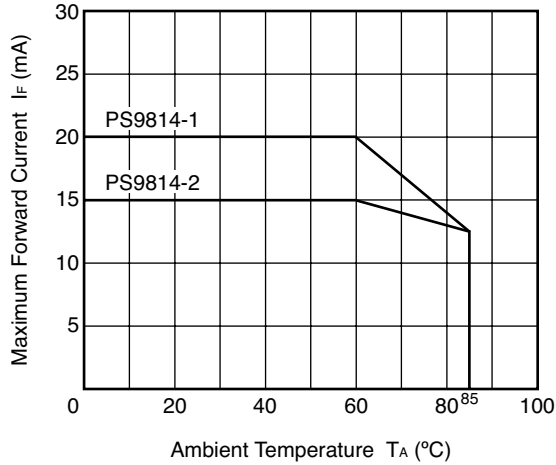

**DETECTOR POWER DISSIPATION vs. AMBIENT TEMPERATURE**

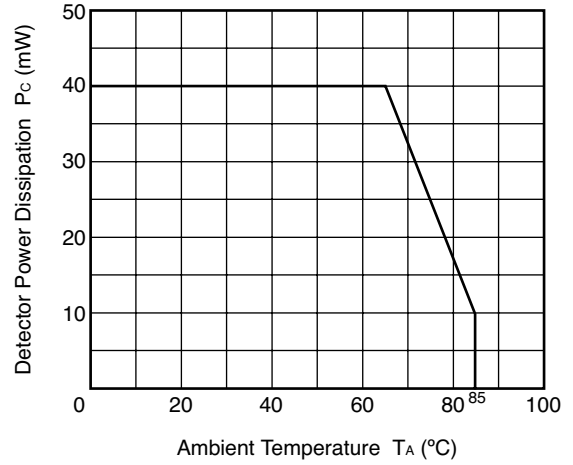

**FORWARD CURRENT vs. FORWARD VOLTAGE**

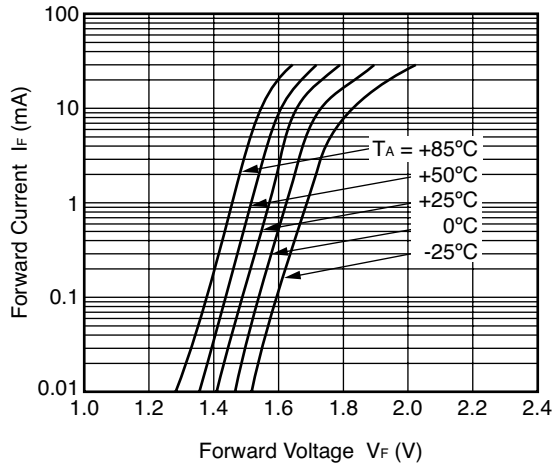

**SUPPLY CURRENT vs. AMBIENT TEMPERATURE**

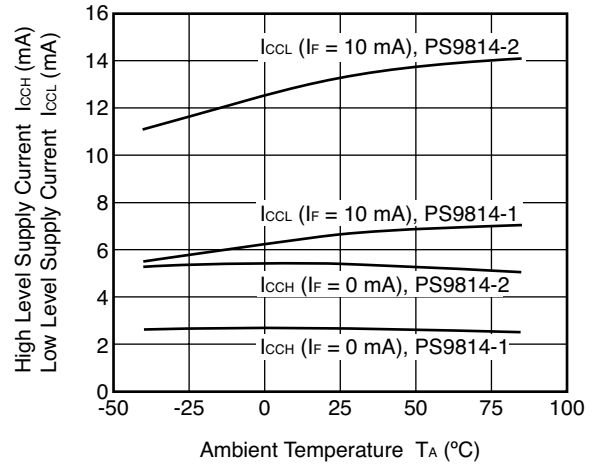

**OUTPUT VOLTAGE vs. INPUT CURRENT**

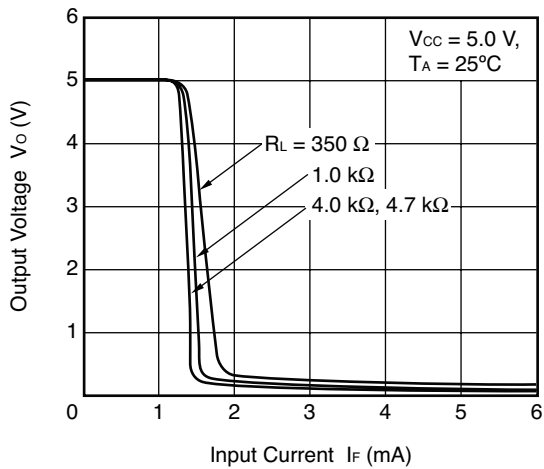

**LOW LEVEL OUTPUT VOLTAGE vs. AMBIENT TEMPERATURE**

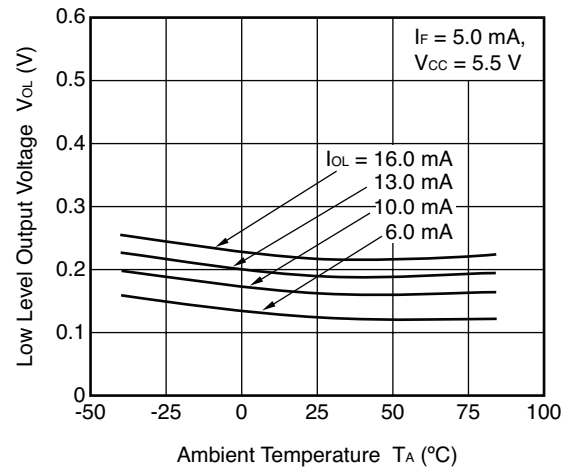

THRESHOLD INPUT CURRENT vs. AMBIENT TEMPERATURE

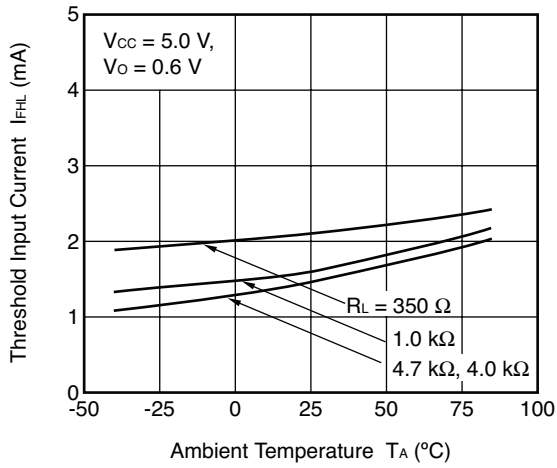

PROPAGATION DELAY TIME vs. AMBIENT TEMPERATURE

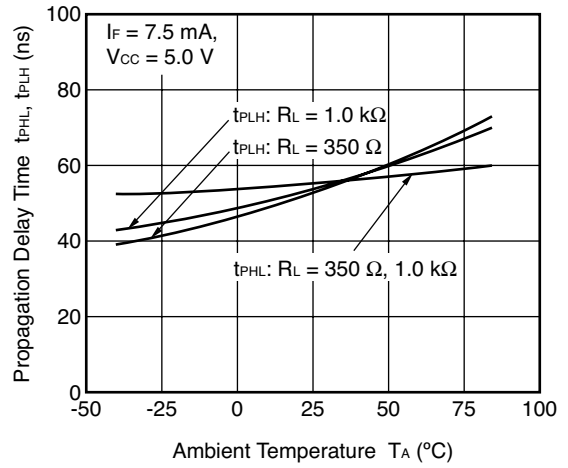

PROPAGATION DELAY TIME vs. AMBIENT TEMPERATURE

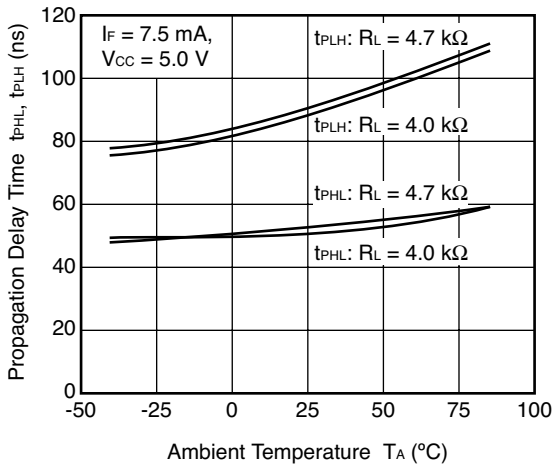

PULSE WIDTH DISTORTION vs. AMBIENT TEMPERATURE

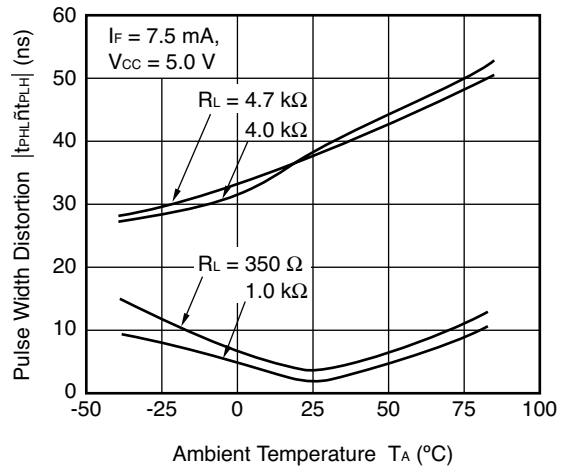

SWITCHING TIME vs. AMBIENT TEMPERATURE

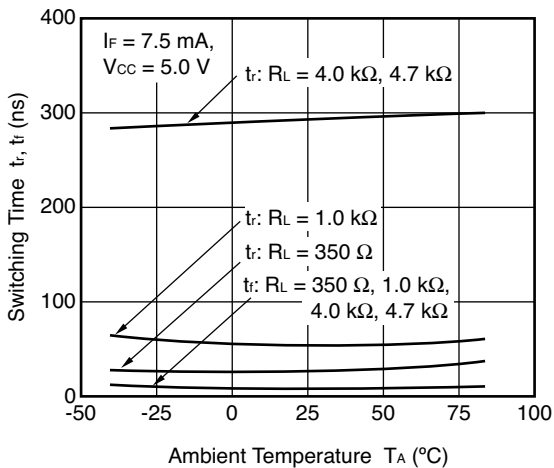

PROPAGATION DELAY TIME vs. INPUT CURRENT

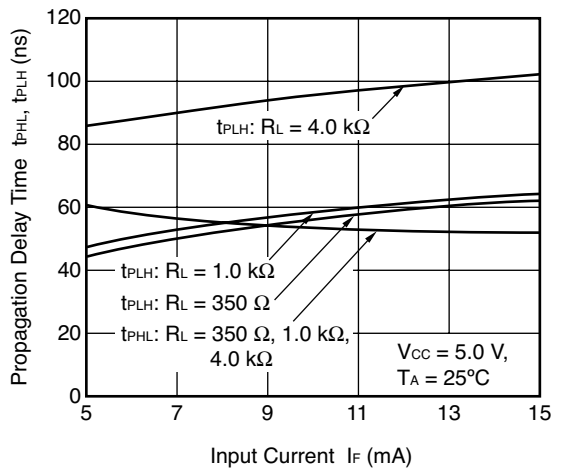

**Remark** The graphs indicate nominal characteristics.



**TAPING SPECIFICATIONS** (Units in mm)

Outline and Dimensions (Tape)

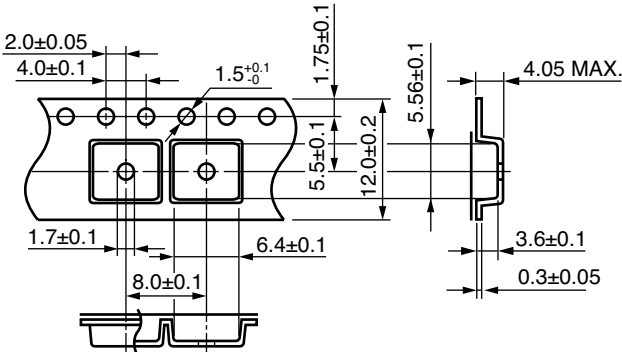

Taping Direction

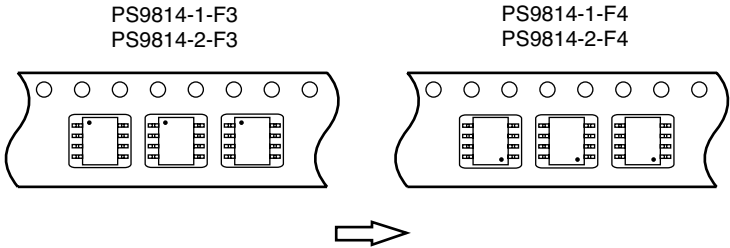

Outline and Dimensions (Reel)

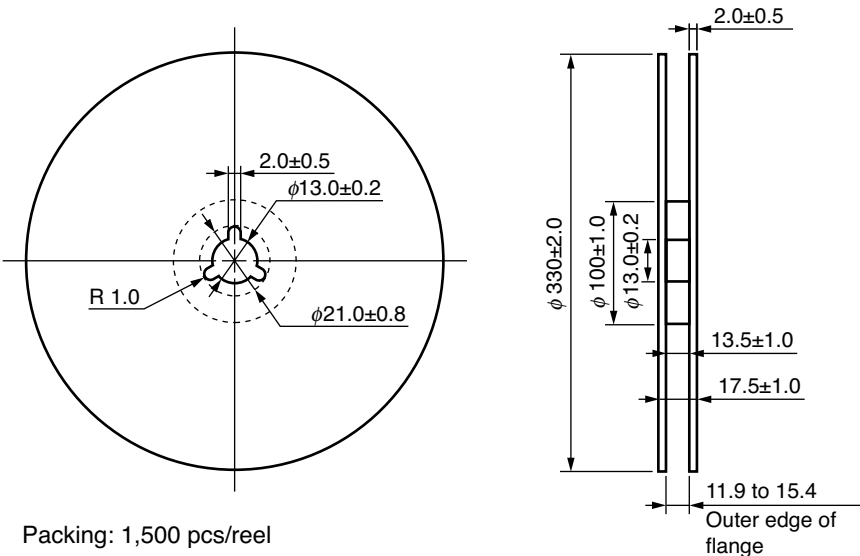

Packing: 1,500 pcs/reel

**Remark** The graphs indicate nominal characteristics.

RECOMMENDED MOUNT PAD DIMENSIONS (UNIT:mm)

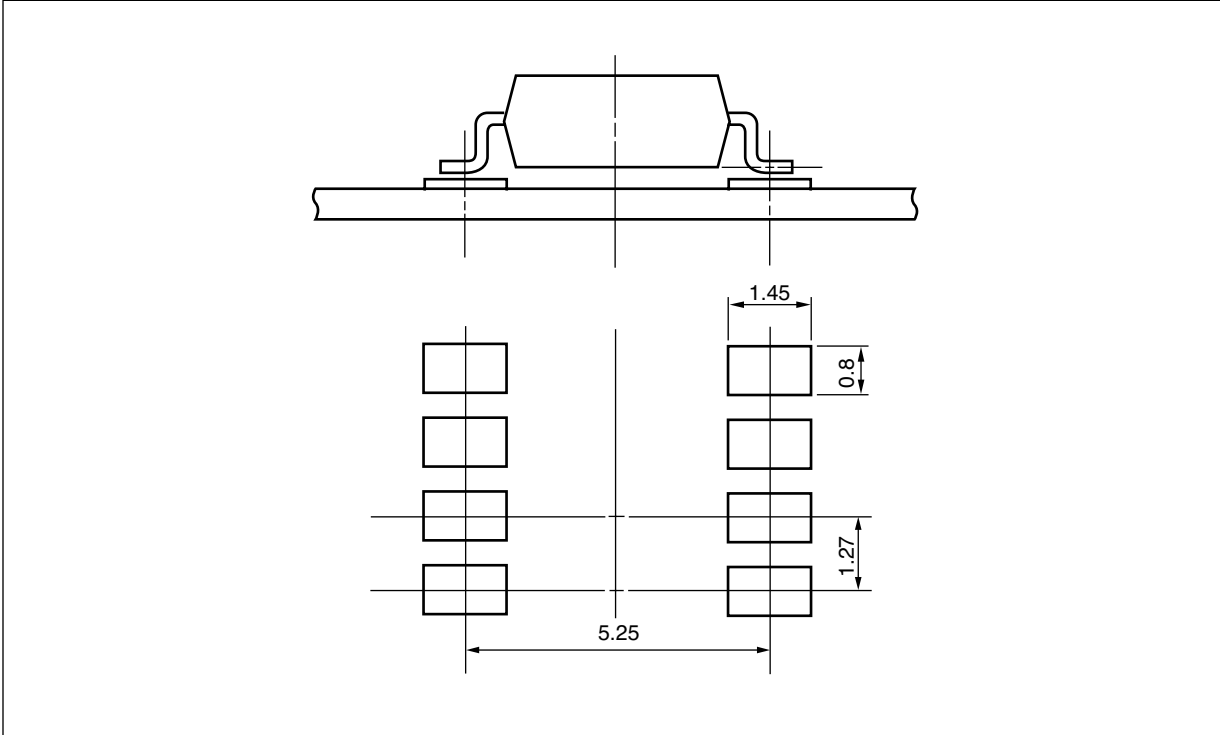

## NOTES ON HANDLING

### 1. Recommended soldering conditions

#### (1) Infrared reflow soldering

- Peak reflow temperature 260°C or below (package surface temperature)
- Time of peak reflow temperature 10 seconds or less
- Time of temperature higher than 220°C 60 seconds or less
- Time to preheat temperature from 120 to 180°C 120±30 s
- Number of reflows Three
- Flux Rosin flux containing small amount of chlorine (The flux with a maximum chlorine content of 0.2 Wt% is recommended.)

Recommended Temperature Profile of Infrared Reflow

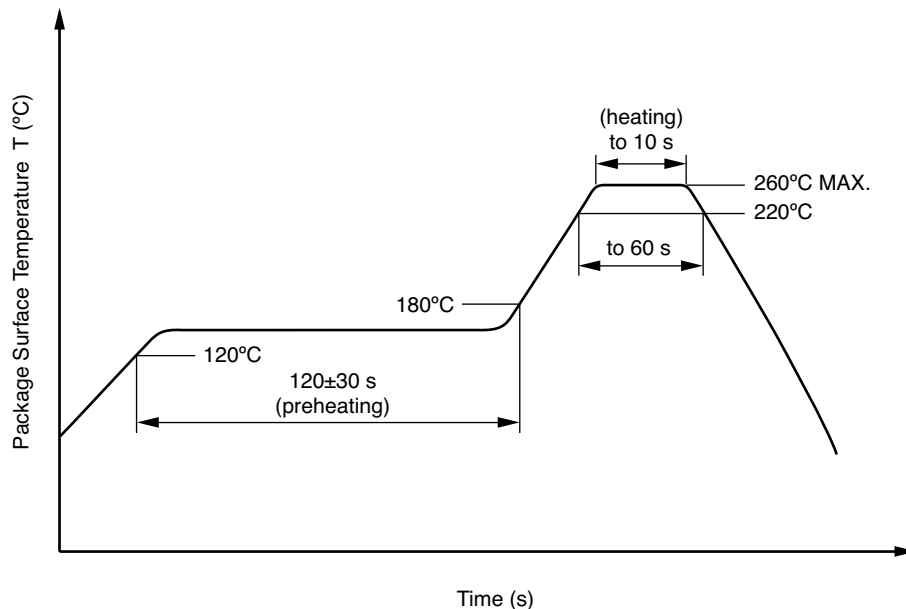

#### (2) Wave soldering

- Temperature 260°C or below (molten solder temperature)
- Time 10 seconds or less
- Preheating conditions 120°C or below (package surface temperature)
- Number of times One (Allowed to be dipped in solder including plastic mold portion.)
- Flux Rosin flux containing small amount of chlorine (The flux with a maximum chlorine content of 0.2 Wt% is recommended.)

#### (3) Soldering by soldering iron

- Peak temperature (lead part temperature) 350°C or below
- Time (each pins) 3 seconds or less
- Flux Rosin flux containing small amount of chlorine (The flux with a maximum chlorine content of 0.2 Wt% is recommended.)

(a) Soldering of leads should be made at the point 1.5 to 2.0 mm from the root of the lead.

(b) Please be sure that the temperature of the package would not be heated over 100°C.

**(4) Cautions**

- Fluxes

Avoid removing the residual flux with freon-based and chlorine-based cleaning solvent.

**2. Cautions regarding noise**

Be aware that when voltage is applied suddenly between the photocoupler's input and output or between collector-emitters at startup, the output transistor may enter the on state, even if the voltage is within the absolute maximum ratings.

**USAGE CAUTIONS**

1. Protect against static electricity when handling.
2. Avoid storage at a high temperature and high humidity.

**Life Support Applications**

These NEC products are not intended for use in life support devices, appliances, or systems where the malfunction of these products can reasonably be expected to result in personal injury. The customers of CEL using or selling these products for use in such applications do so at their own risk and agree to fully indemnify CEL for all damages resulting from such improper use or sale.

**CEL** California Eastern Laboratories, Your source for NEC RF, Microwave, Optoelectronic, and Fiber Optic Semiconductor Devices.

4590 Patrick Henry Drive • Santa Clara, CA 95054-1817 • (408) 988-3500 • FAX (408) 988-0279 • [www.cel.com](http://www.cel.com)

DATA SUBJECT TO CHANGE WITHOUT NOTICE

02/07/2005

**NEC**  
A Business Partner of NEC Compound Semiconductor Devices, Ltd.